

INSTALLATION INSTRUCTIONS

HDX MODULAR GRILLE GUARD



APPLICATION: 2024 TOYOTA TACOMA

PART NUMBER: 57-22785

CONTENT			
ITEM	QUANTITY	DESCRIPTION	TOOLS NEEDED
1	1	HDX GRILLE GUARD BASE	13MM SOCKET
2	1	HDX DRIVER WING	16MM SOCKET
3	1	HDX PASSENGER WING	18MM SOCKET
4	1	DRIVER MOUNT BRACKET	RATCHET
5	1	PASSENGER MOUNT BRACKET	5MM ALLEN KEY
6	1	DRIVER TRIMMING TEMPLATE	
7	1	PASSENGER TRIMMING TEMPLATE	
8	4	M12 HEX HEAD BOLT (YELLOW ZINC)	
9	4	M12 FLAT WASHER (YELLOW ZINC)	
10	4	M12 SPLIT LOCK WASHER (YELLOW ZINC)	
11	4	M12 SERRATED FLANGED HEX NUT (YELLOW ZINC)	
12	6	M10 BUTTON HEAD BOLT (BLACK ZINC)	
13	6	M10 BELLEVILLE WASHER (BLACK ZINC)	
14	6	M10 SERRATED FLANGED HEX NUT (BLACK ZINC)	
15	10	M8 BUTTON HEAD BOLT (BLACK ZINC)	
16	10	M8 BELLVILLE WASHER (BLACK ZINC)	
17	10	M8 SERRATED FLANGED HEX NUT (BLACK ZINC)	

ANTI-SEIZE LUBRICANT MUST BE USED ON ALL STAINLESS STEEL FASTENERS TO PREVENT THREAD DAMAGE AND GALLING

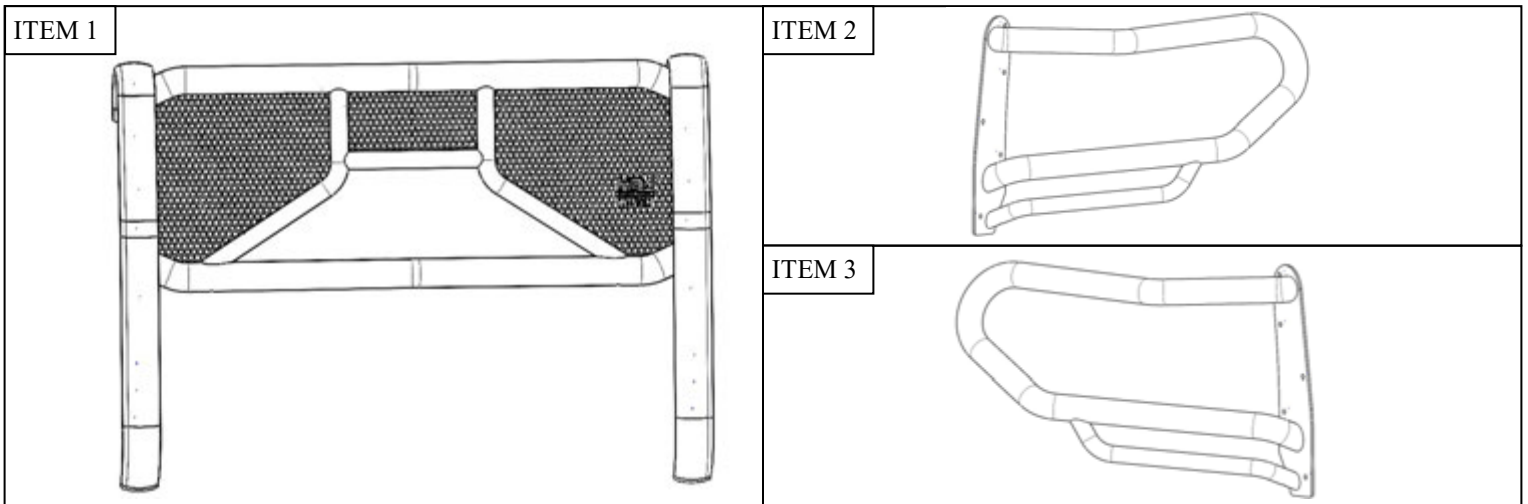

ITEM 4

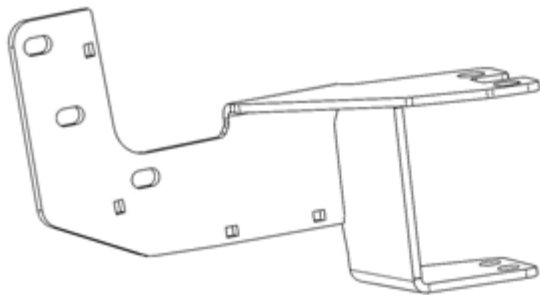

ITEM 5

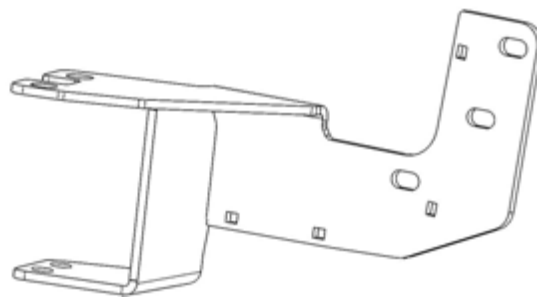

PROCEDURE

1. Remove contents from box, verify if all parts listed are present and free from damage. Carefully read and understand all instructions before attempting installation.
Failure to identify damage before installation could lead to a rejection of any claim.
2. Open the hood of the vehicle. Locate and remove the plastic pins from the air intake duct and plastic cover as indicated below, **(Figure 1)**. Remove and place aside the air intake duct and plastic cover.



Figure 1



Westin Automotive Products, Inc.
320 W. Covina Blvd
San Dimas, Ca. 91773

Thank you for choosing Westin products
for additional installation assistance please call
Customer Service (800) 793-7846
www.westinautomotive.com

3. Next, remove (4) hex bolts indicated below using a 10MM socket (**Figure 2 & 3**). Disconnect any wiring harnesses found behind the front grille/bumper, (**Figure 4**).

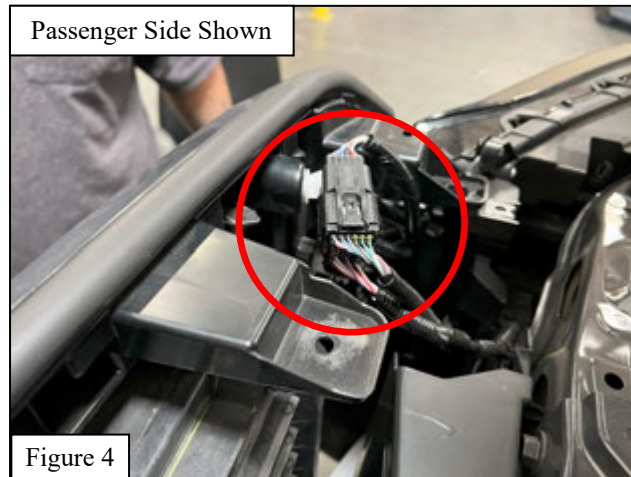
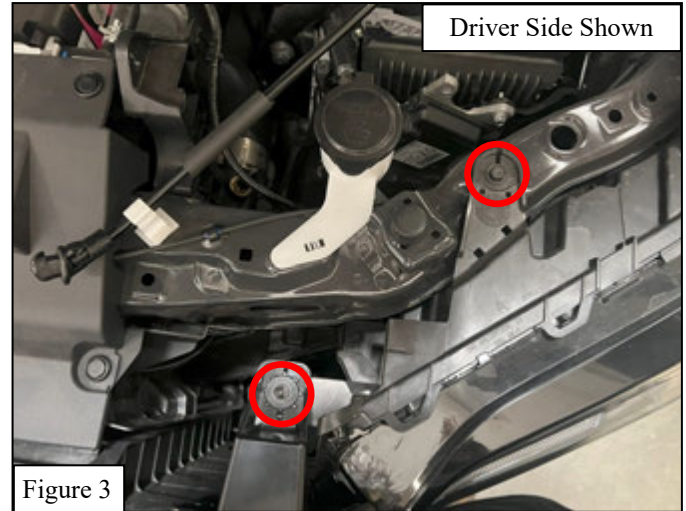
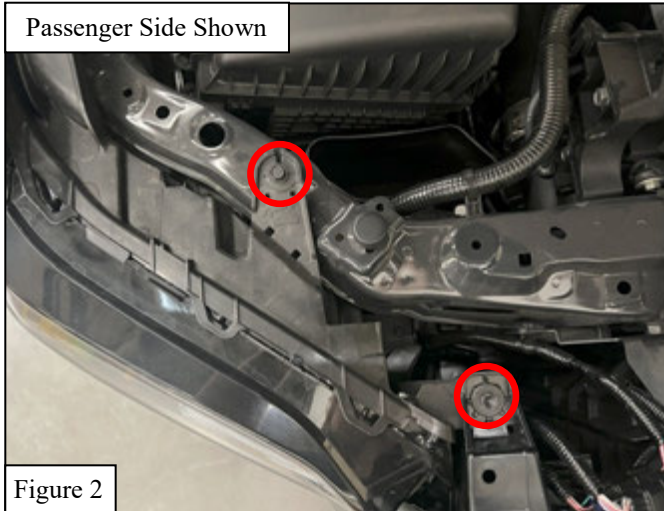

4. Remove the (3) 10mm hex bolts found in the front of the wheel well, as well as the two pins (**Figure 5 & 6**). Note: There is a hex bolt located on the bottom of the vehicle. Repeat this process for the other side of the vehicle.



5. If equipped, carefully pry off the fender flares from both driver and passenger side by releasing the two clips found within the wheel well, and set them aside safely, (**Figure 7**). Locate and remove the Phillips head screw found behind the fender flare. Repeat for both sides, (**Figure 8**).

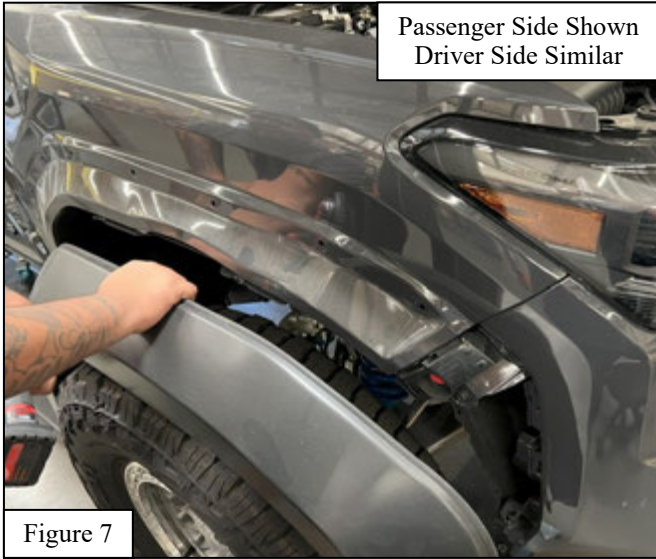

6. Remove the (8) 10mm bolts located on the bottom side of the front grille. There are (3) bolts on either corner of the bottom bumper, and (2) bolts located in the center, on the back edge of the plastic skid plate. Carefully pry the front grille off the upper clips and remove the grille and bumper.
7. Remove (8) 10mm bolts from the crash bar. On each side, (2) bolts are located on the bottom and (2) bolts are located on the top. See **Figures 9 and 10**.

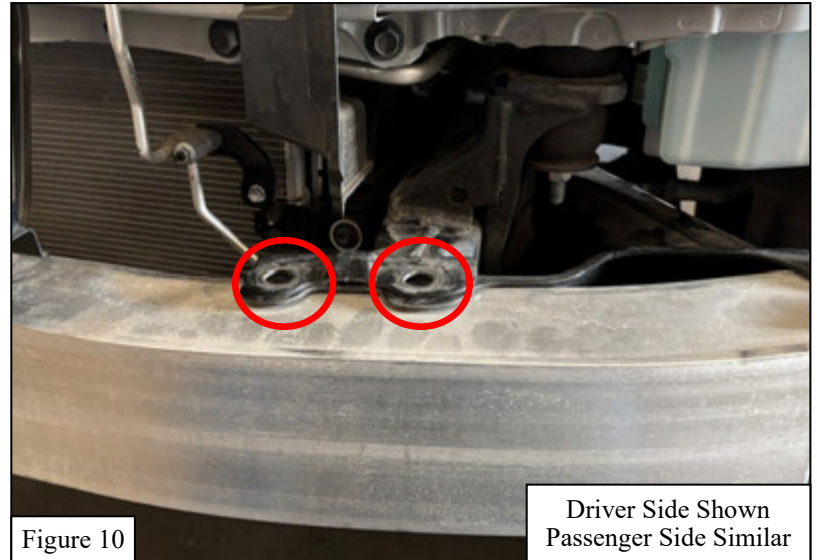
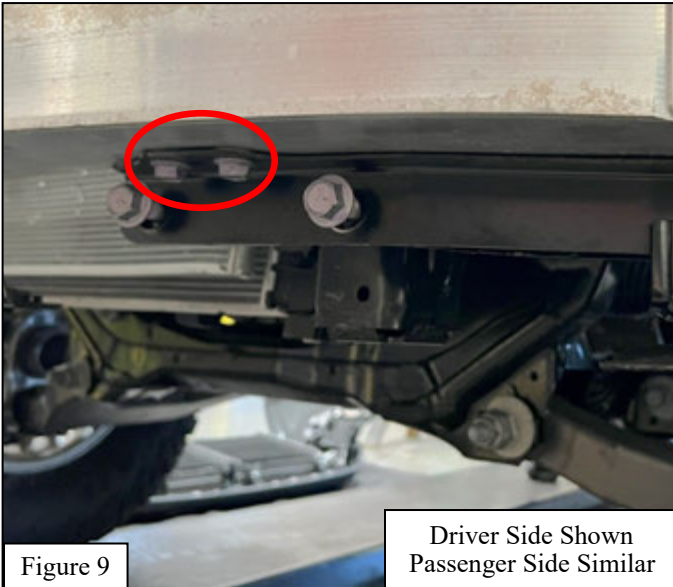

8. Loosely install the Mount Brackets (**items 4 and 5**) using the hardware removed in the previous step. See **Figures 11 and 12**.
9. Install the HDX Grille Guard Base (**item 1**) onto the Mount Brackets using the M10 hardware (**items 12-14**). See **Figure 13**.
10. Adjust and align the brackets.
11. Tighten the hardware attaching the Mount Brackets to the truck.
12. Remove the HDX Grille Guard.

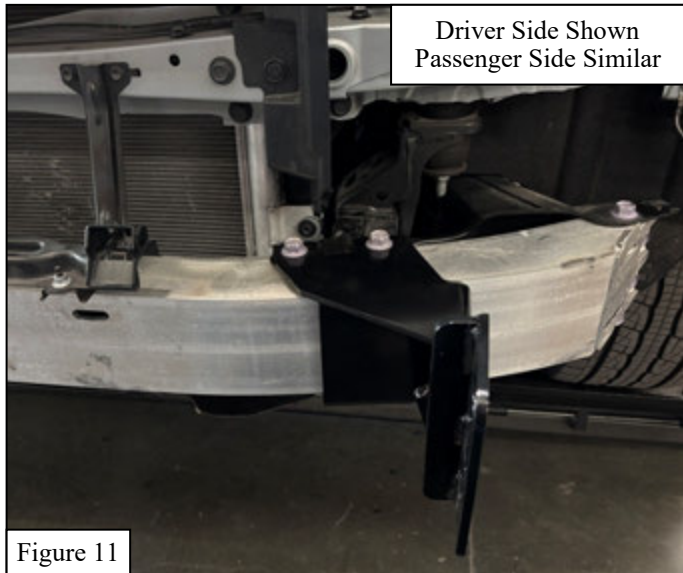

Figure 11

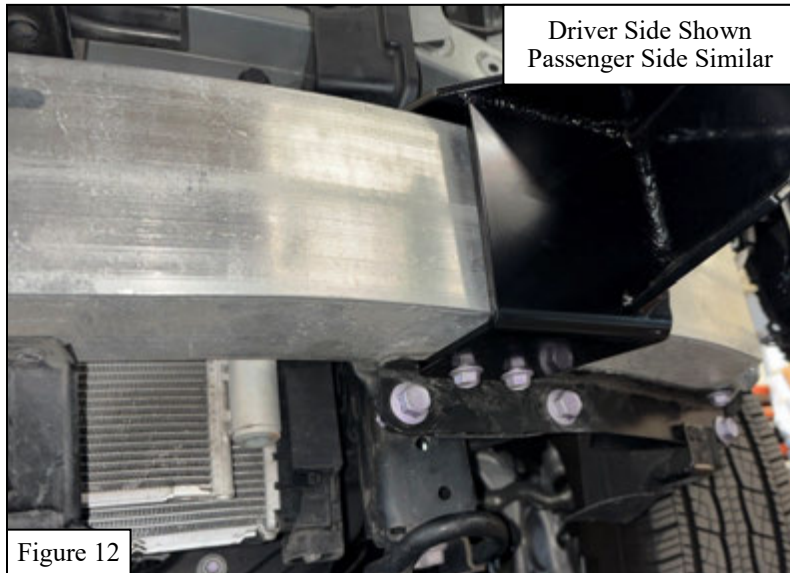

Figure 12

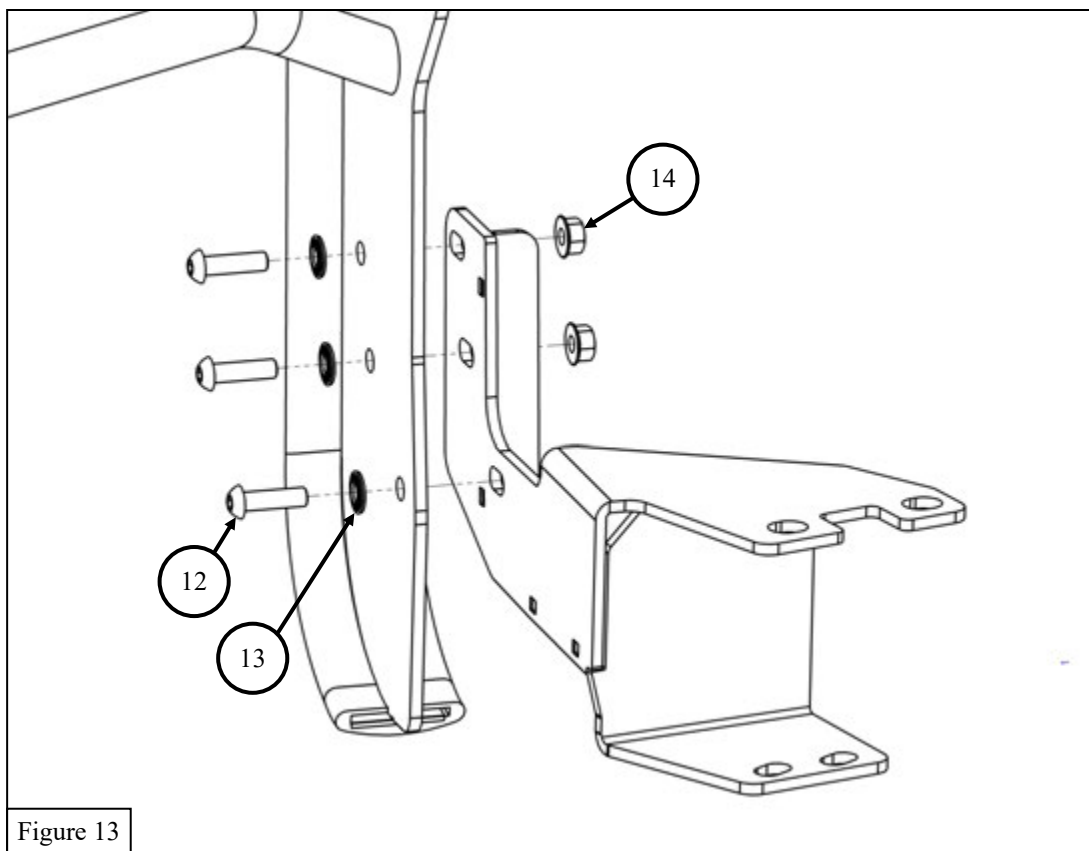
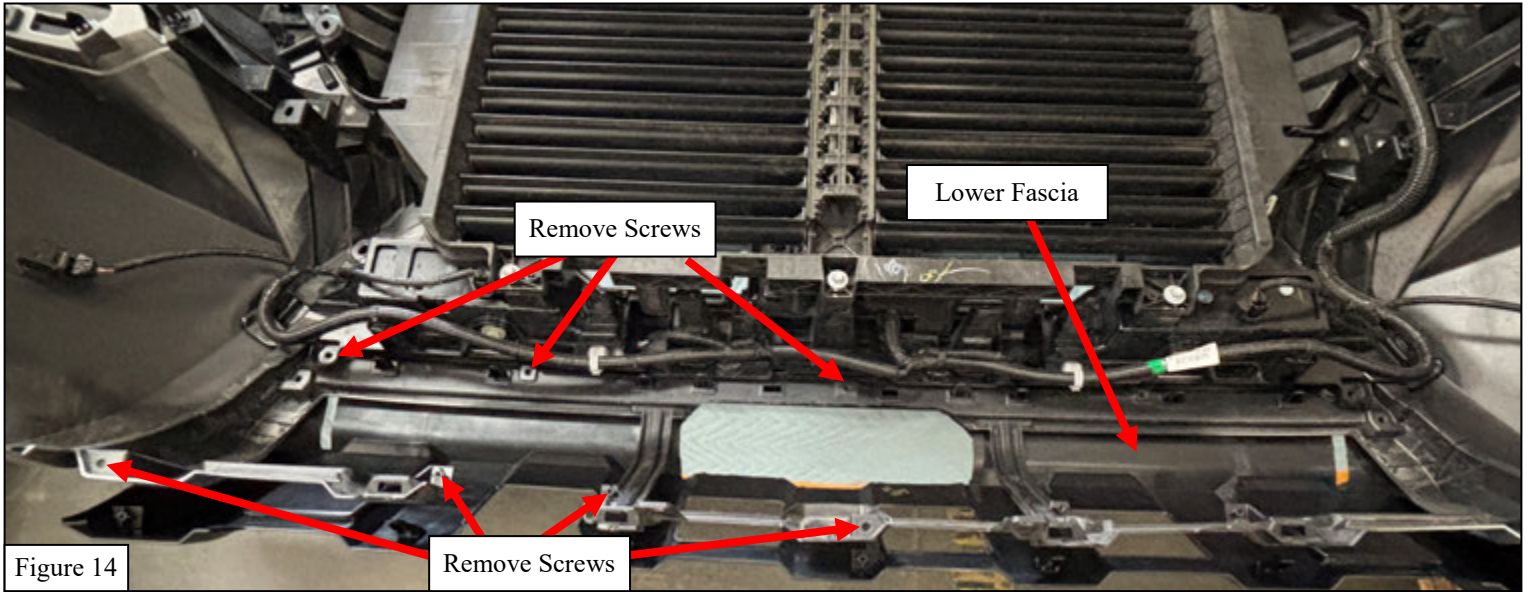
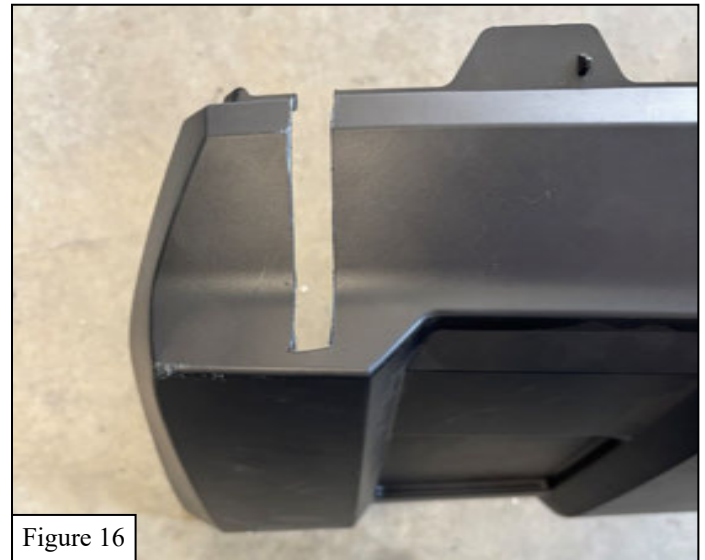
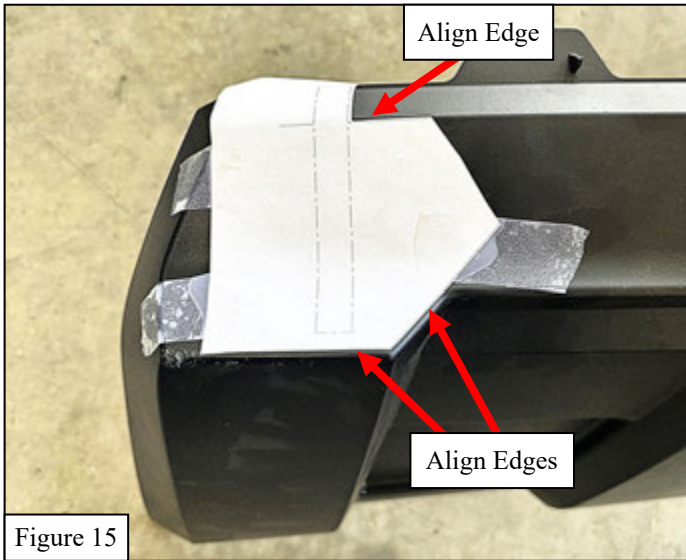

Figure 13

13. Remove the lower fascia from the bumper. See **Figure 14**. Remove the screws holding the lower fascia in place. Release the clips at the top of the lower fascia holding it in place.



14. Attach the Trimming Templates (items 6 and 7) to the lower fascia aligning the template solid lines to the edges indicated below. Trim along the dashed lines. See **Figures 15 and 16**.



15. Reinstall the lower fascia onto the bumper.
16. Mark the bumper matching the lines trimmed from the lower fascia. See **Figures 17 and 18**.
17. Trim the bumper. See **Figure 19**.

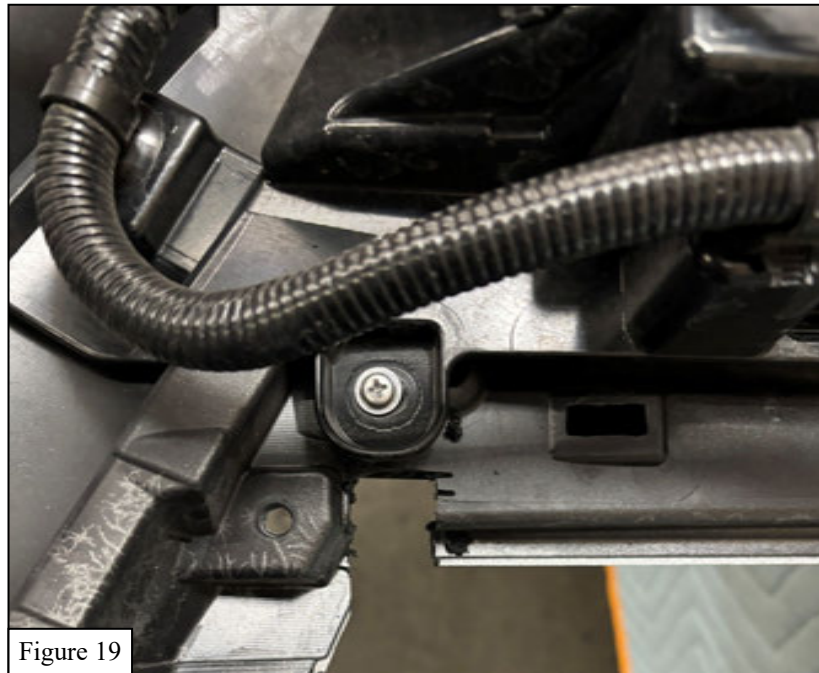
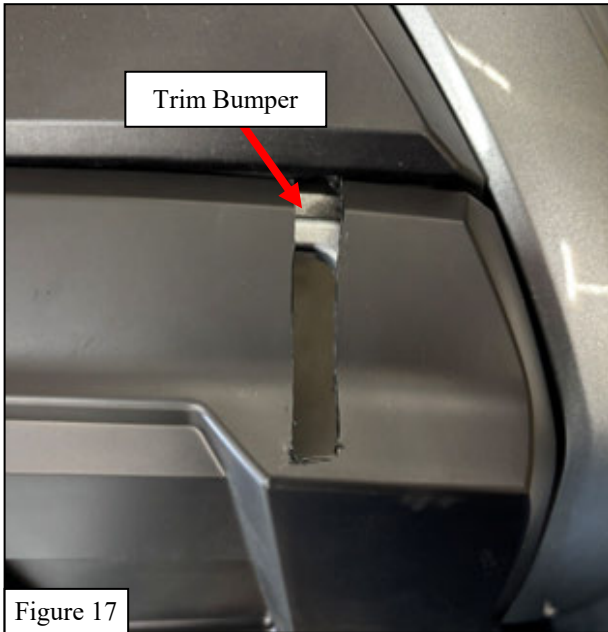

18. Reinstall the bumper.
19. Reinstall the lower fascia sliding the trimmed sections around the Mount Brackets.
20. Install the HDX Grille Guard Base (**item 1**) onto the Mount Brackets. See **Figure 13**.
21. Attach the Driver and Passenger Wings (**items 2 and 3**) using the M8 hardware. See **Figures 20 and 21**.
22. Tighten the hardware as specified: M8 to 15-18 ft-lbs. and M10 to 25-30 ft-lbs.

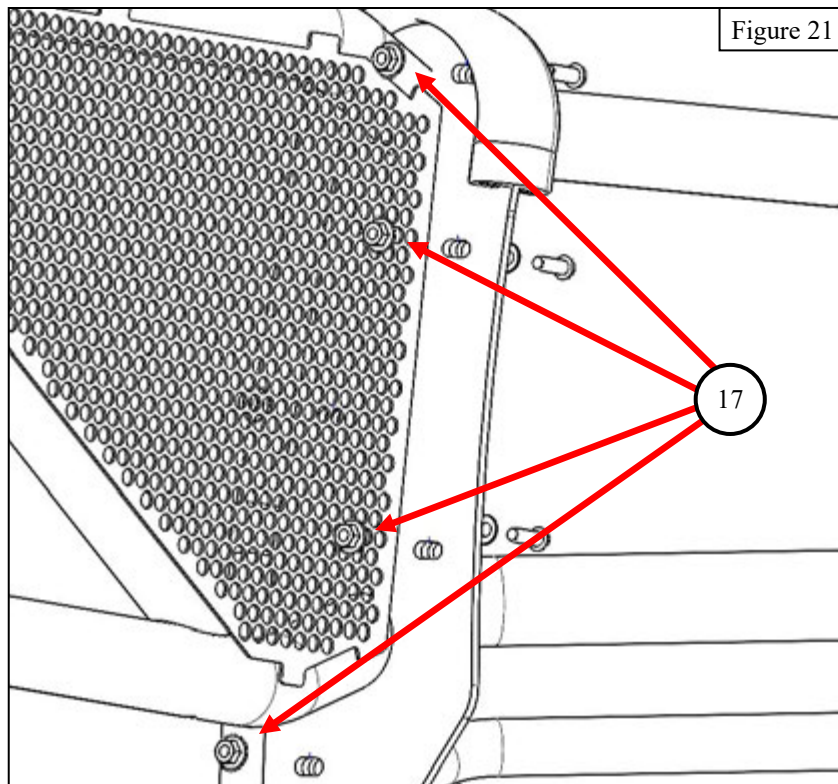
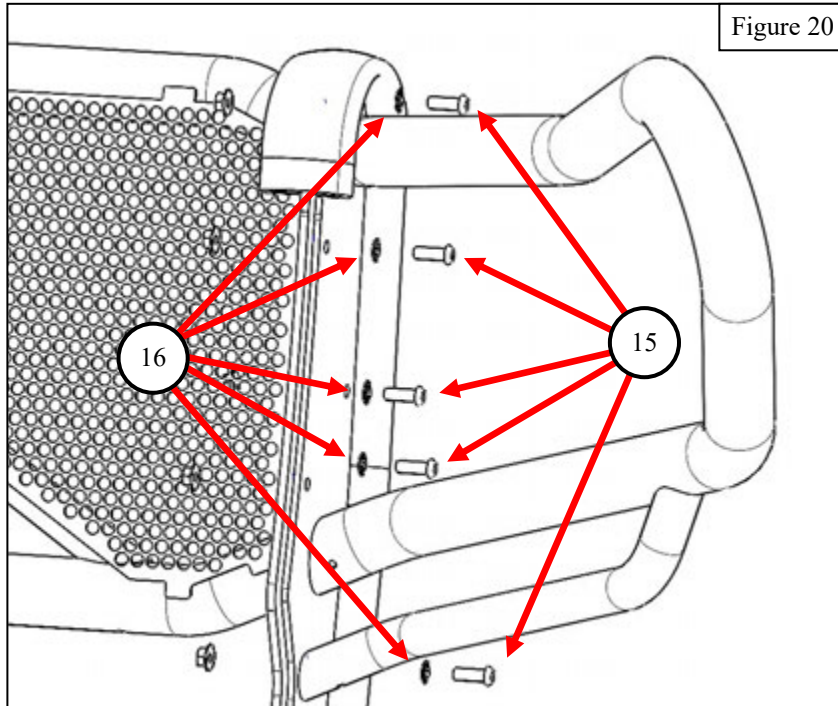

INSTALLATION COMPLETE



CARE INSTRUCTIONS

- REGULAR WAXING IS RECOMMENDED. DO NOT USE ANY TYPE OF POLISH OR WAX THAT MAY CONTAIN ABRASIVES.
- STAINLESS STEEL PRODUCTS CAN BE CLEANED WITH MILD SOAP AND WATER. STAINLESS STEEL POLISH SHOULD BE USED TO POLISH SMALL SCRATCHES.
- GLOSS BLACK FINISHES SHOULD BE CLEANED WITH MILD SOAP AND WATER.

WESTIN

Westin Automotive Products, Inc.
320 W. Covina Blvd
San Dimas, Ca. 91773

Thank you for choosing Westin products
for additional installation assistance please call
Customer Service (800) 793-7846
www.westinautomotive.com



WARNING



Failure to follow these instructions could lead to death, personal injury, and / or property damage.

Failure to follow these instructions could lead to death, personal injury, and / or property damage.

FASTENERS:

All Westin supplied fasteners must be utilized and installed in accordance with the installation instructions and apply torque to the specifications as defined. **DOUBLE CHECK ALL FASTENERS BEFORE INITIAL USE, AND PERIODICALLY IN THE FUTURE TO ENSURE PROPER FUNCTION AND SAFETY.**

DRILLING:

Most Westin products do not require drilling for installation. If drilling is defined as required, use caution when drilling a vehicle. **FAILURE TO REVIEW AN AREA TO BE DRILLED MAY RESULT IN PERSONAL INJURY AND/OR INJURY TO OTHERS AS WELL AS VEHICLE DAMAGE.**

EYE PROTECTION:

ALWAYS WEAR SAFETY GLASSES OR GOGGLES DURING THE INSTALLATION PROCESS TO AVOID PERSONAL INJURY.

MAXIMUM TOWING/CARRYING CAPACITY: (if applicable)

The Westin Receiver Hitches will have a visible tow rating label affixed directly on the product. User should never exceed the vehicle manufacturers maximum tow and weight rating regardless of the capacity of the hitch. **FAILURE TO FOLLOW THESE GUIDELINES WILL VOID THE WESTIN WARRANTY AND MAY RESULT IN PERSONAL INJURY AND/OR INJURY TO OTHERS AS WELL AS VEHICLE DAMAGE.**

FOR CALIFORNIA RESIDENTS ONLY-PROP 65 WARNING:

Some products may contain chemicals such as DEHP, which can cause cancer, birth defects or other reproductive harm. For more info go to www.p65warnings.ca.gov



Westin Automotive Products, Inc.
320 W. Covina Blvd
San Dimas, Ca. 91773